

ATIVIDADE DE REVISÃO ANUAL - 2021

1. MATCH THE GREETINGS WITH THE PICTURES. (LIGUE OS CUMPRIMENTOS ÀS IMAGENS).

A GOOD MORNING.



B GOOD NIGHT.



C GOODBYE.



D HELLO!



2. FIND THE FAMILY MEMBERS NAMES. (ENCONTRE OS NOMES DOS MEMBROS DA FAMÍLIA).



3. LOOK AT THE PICTURES AND MARK THE CORRECT OPTION. (OBSERVE AS IMAGENS E MARQUE A OPÇÃO CORRETA).



- THIS IS MY DAD.
- THIS IS MY BABY SISTER.
- THIS IS MY MOM.



- THIS IS MY BROTHER.
- THIS IS MY BABY BROTHER.
- THIS IS MY DAD.



- THIS IS MY MOM.
- THIS IS MY BABY BROTHER
- THIS IS MY DAD.



- THIS IS MY MOM.
- THIS IS MY BABY SISTER.
- THIS IS MY SISTER.

4. LOOK, READ AND COLOR THE PICTURES ACCORDING TO THE DESCRIPTIONS. (OBSERVE, LEIA E PINTE AS IMAGENS DE ACORDO COM AS DESCRIÇÕES).

1. COLOR THE SWING WITH YELLOW.

2. COLOR THE BIKE WITH PURPLE.

3. COLOR THE BALL WITH ORANGE.

4. COLOR THE SLIDE WITH RED.

5. COLOR TH SEESAW WITH GREEN.

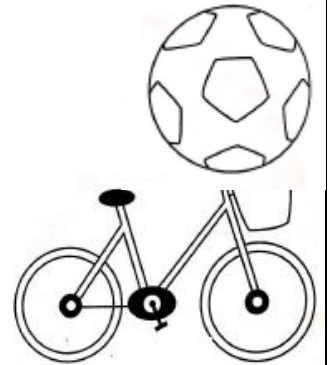
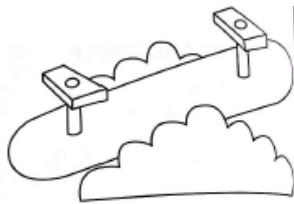
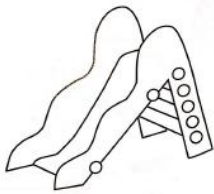

5. COUNT AND CHECK (✓). HOW MANY ANIMALS? (CONTE E MARQUE. QUANTOS ANIMAIS?).

A

FOUR SEVEN

B

EIGHT NINE

C

TWO FOUR

D

SEVEN FIVE

E

EIGHT SIX

F

THREE TWO

6. LOOK AND CHECK (✓). WHAT'S MISSING? (OBSERVE E MARQUE. O QUE ESTÁ FALTANDO?)



WHAT'S MISSING?



BALL



BOAT



CAR



DOLL



SKATEBOARD



TEDDY BEAR



VIDEO GAME

7. CONNECT THE DOTS AND CIRCLE THE CORRECT ANSWER. (CONECTE OS PONTOS E CIRCULE A RESPOSTA CORRETA).

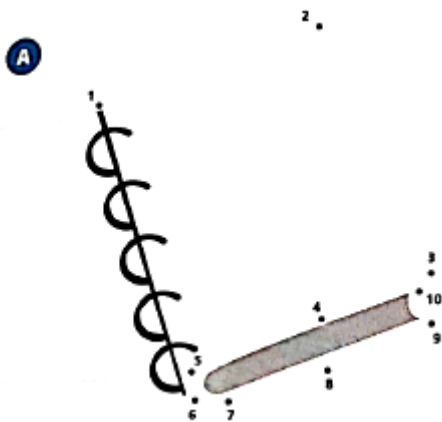

A: WHAT'S THIS?
B: IT'S A PEN / NOTEBOOK.

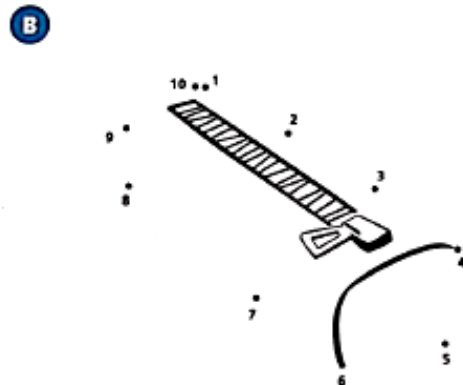

A: WHAT'S THIS?
B: IT'S A PENCIL / PENCIL CASE.

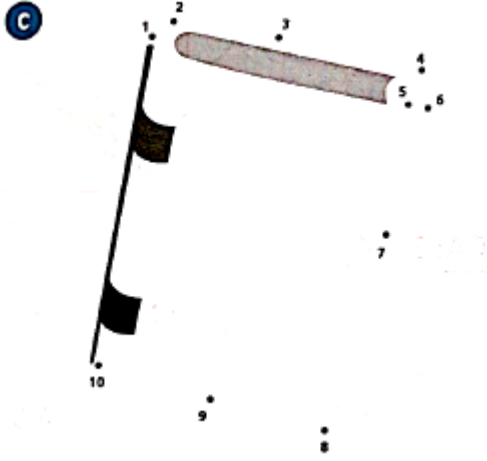

A: WHAT'S THIS?
B: IT'S A BOOK / PEN.

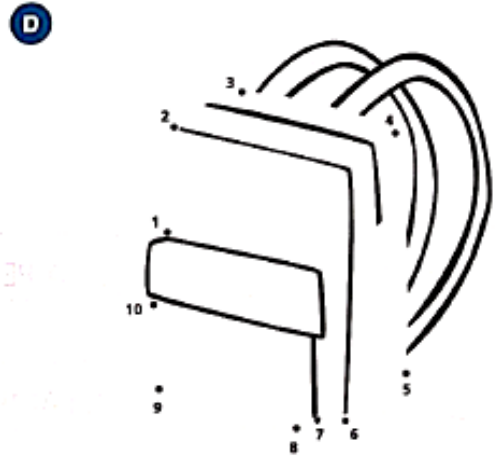

A: WHAT'S THIS?
B: IT'S A BACKPACK / PENCIL.

8. LOOK AND CHECK (✓). (OBSERVE E MARQUE).

IN MY BACKBACK, I HAVE...



- ... A PEN.
- ... A LAMP.
- ... A RABBIT.
- ... A BOOK.
- ... A DESK.
- ... A PENCIL CASE.
- ... AN ERASER.
- ... A HAMSTER.
- ... A SLIDE.
- ... A PENCIL.

9. READ, CIRCLE AND COLOR. (LEIA, CONTORNE E PINTE).

EAR	
EYE	
MOUTH	

10. COUNT AND COLOR. (CONTE E PINTE).

A

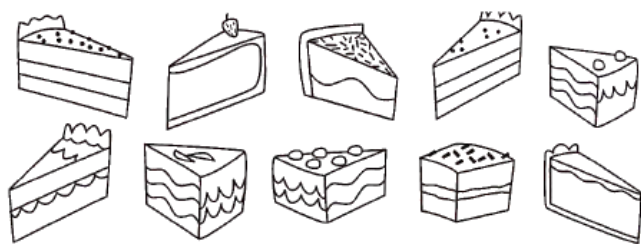

FOUR CAKES.

D



NINE SANDWICHES.

B

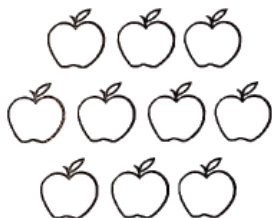

FIVE APPLES.

C



EIGHT BANANAS.

E

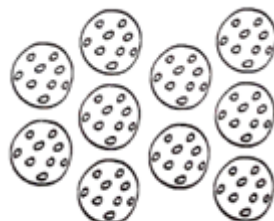

SEVEN COOKIES.

